

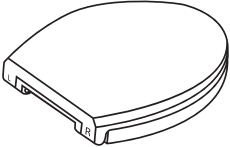

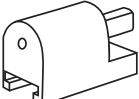





Important: If parts are missing, please contact Beldray at customersupport@beldray.com

Parts

A	Toilet seat 	B	Hinges  x 2 pcs
C	Bolts  x 2 pcs	D	Metal plates  x 2 pcs
E	Stoppers  x 2 pcs	F	Centering discs  x 2 pcs
G	Plastic washers  x 2 pcs	H	Metal washers  x 2 pcs
I	Nuts  x 2 pcs	J	Assembly tool 

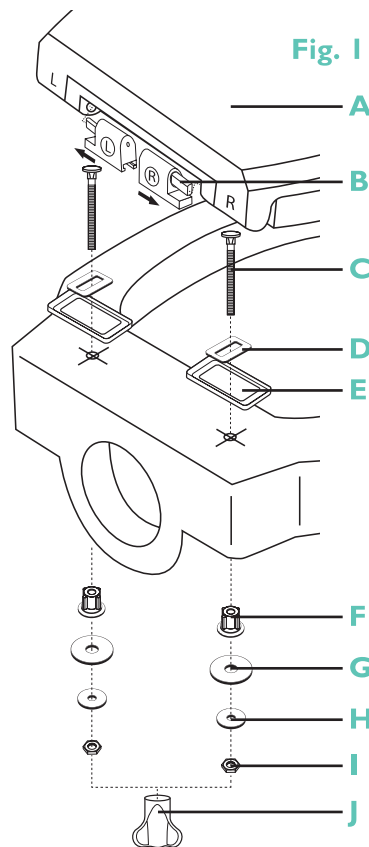

Fig. 2

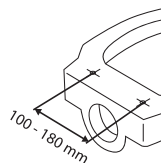
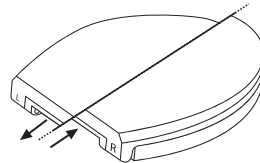

Fig. 3



Soft-close Duroplastic Toilet Seat Instruction Manual

Refer to fig.1 when following the below steps:

STEP 1: Attach the hinges to the toilet seat by inserting them into the corresponding openings. The hinges and the openings are both marked 'L' (left) and 'R' (right) for easy installation.

STEP 2: Slide the metal plates over the bolts and then insert the assembled bolts into the hinges. Attach the stoppers to the hinges.

STEP 3: Align the bolts that have been inserted into the toilet seat with the mounting holes in the toilet pan.

STEP 4: Fix the toilet seat into position by placing it onto the toilet pan and then inserting the bolts through the mounting holes.

STEP 5: Add the centring discs onto the bolts, followed by the plastic and metal washers.

STEP 6: Secure the toilet seat into position with the nuts and carefully tighten using the assembly tool included.

Note: Check the position of the hinges regularly, then readjust to the correct position and tighten the nuts if necessary.

It is possible to slide the bolts and metal plates to the inside or outside position until the toilet seat is correctly aligned with the mounting holes in the toilet pan (fig 2).

If the toilet seat overhangs the toilet pan, either at the front or the back, readjust the screw heads within the metal plates (fig 3).

Instructions for Use

This toilet seat features a slow closing function, which when pushed lightly will automatically lower and close itself.

The lid should only be lifted to a maximum angle of 110 °.

Care and Maintenance

The toilet should be cleaned regularly for hygiene purposes. Wipe the toilet seat with a soft, damp cloth and a mild detergent; allow to dry thoroughly.

Do not use harsh or abrasive cleaning agents or scourers to clean the toilet seat, as this could cause damage.

Caution

Do not stand on the lid or ring of the toilet seat.

Do not use the toilet seat as a normal seat.

Do not push down on the lid whilst it is closing.

Warning

This product is not a toy.

Keep out of the reach of children.

For domestic use only, not recommended for commercial purposes.